



MARTE

design Studio Tecnico Alis Italia 2016

MARTE completa una serie di modelli da appoggio e contiene fino a 20 bottiglie con quattro spazi bottiglia distribuiti sui due lati.

MARS completes the series of models of support. It holds up to 20 bottles with four bottle spaces distributed on each side.



MARTE 20 HP

MARTE 20

capacità 20 bottiglie
metacrilato trasparente 08 mm
elementi di appoggio massello di faggio colore rovere chiaro sp. 25 mm
dimensioni P 579 x L 384 x H 810 mm
peso 9,00 kg / LM / MD - 11 kg / HP - 10 kg / MT
volume 0,046 mc
sistema in kit
1 pallet (1 x 1,20 x 0,65 m) - 8 pz

*capacity 20 bottles
transparent methacrylate 8 mm
support elements in solid beech light oak color sp . 25 mm
dimensions D 579 x W 384 x H 810 mm
weight 9,00 kg / LM / MD - 11 kg / HP - 10 kg / MT
volume 0,046 mc
kit system
1 pallet (1 x 1,20 x 0,65 m) - 8 pcs*

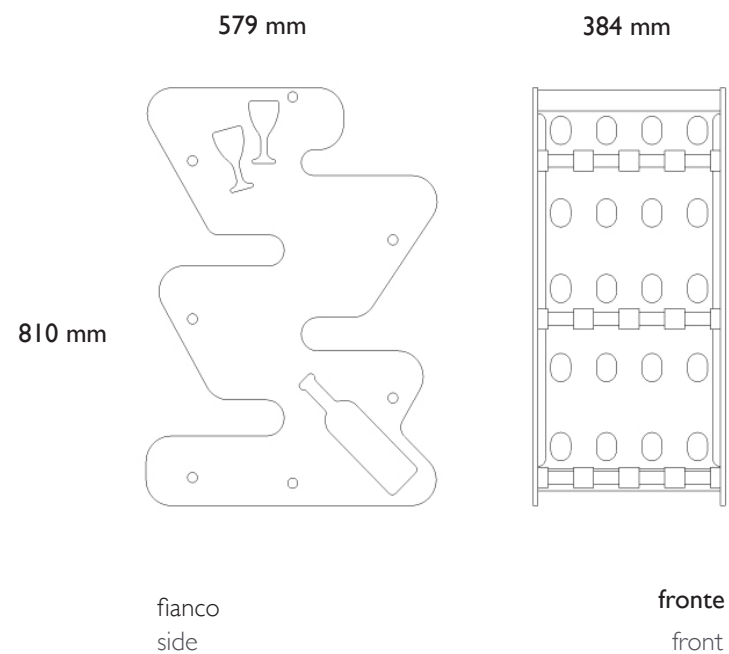

MARTE 20-MD

versione MDF colorato in pasta | MDF version paste colored

MD
01 nero

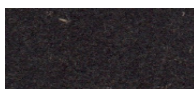

MD
01 black

MD
02 antracite

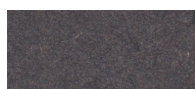

MD
02 anthracite

MD
03 grigio perla

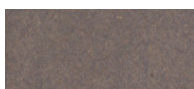

MD
03 light gray

MD
04 viola



MD
04 violet

MD
05 marrone scuro

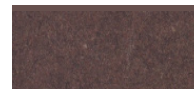

MD
05 dark brown

MD
06 marrone chiaro



MD
06 light brown

MD
07 blu



MD
07 blu

MD
08 verde scuro

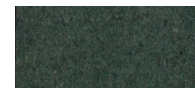

MD
08 dark green

MD
06 marrone chiaro

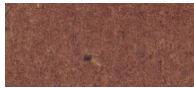

MD
06 light brown

MD
10 rosso



MD
10 red

MD
11 arancio

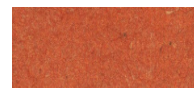

MD
11 orange

MD
12 giallo



MD
12 yellow

MARTE 20-HP

versione HPL | HPL version

HP
01 nero



HP
01 black

MARTE 20-MT

versione metacrilato | methacrylate version

MT
00 trasparente



MT
00 transparent

MARTE 20-LM

versione legno multistrati | multilayer wood

LM
Natural



LM
Natural

LM
Olio



LM
Oil